

IMPORTANT SAFETY INSTRUCTIONS

L100 SERIES
OWNER'S MANUAL



VITA INTERNATIONAL
2320 N.W. 147th Street Miami, Florida 33054

h e a l t h a n d r e l a x a t i o n f o r l i f e

IMPORTANT SAFETY INSTRUCTIONS

**L100 SERIES
OWNER'S MANUAL**



**VITA INTERNATIONAL
2320 N.W. 147th Street Miami, Florida 33054**



**L100 SERIES
OWNER'S MANUAL**

**VITA INTERNATIONAL
2320 N.W. 147th Street Miami, Florida 33054**

OWNER'S RECORD

DATE PURCHASED: _____

DATE INSTALLED: _____

DEALER: _____

ADDRESS: _____

TELEPHONE: _____

* SERIAL #: _____

MODEL #: _____

To contact our Technical Service Department, please write to Vita International, 2320 NW 147th Street, Miami, FL 33054 or call 1-305-685-2063, during normal business hours, Monday through Friday, 8:30 am to 5pm, EST.

* The Serial Number is located along the base of the spa. Please verify that the serial number is noted on your dealer's purchase contract.

TABLE OF CONTENTS

GENERAL INFORMATION

- Owner's Record and Service Information frontpiece
- **Important** Safety Instructions..... 2-3
- Manufacturer's Do's and Don'ts 3
- **WARNINGS** 4

SET UP AND INSTALLATION

- Site Selection/LOCAL CODES..... 5
- Clearances..... 6
- Electrical Requirements and Installation.....7-11
- Cover Installation..... 12

OPERATION INSTRUCTIONS

- Initial Startup..... 13
 - A. Setting Temperature..... 13
 - B. Auto Heat And Economy Mode..... 13
 - C. Setting Current Time..... 14
 - D. Setting Filtration Cycles..... 14
- Using Your Spa14
 - A. Displaying Time or Temperature 14
 - B. Water Jet Therapy 14
 - C. Turning on the Light 15
- Special Features 15
 - A. Automatic Jets Purge on 2 Pump Systems 15
 - B. Memory 15
 - C. System Reset 15
 - D. Panel Lock 15
 - E. Freeze Protection 15
 - F. Flow Protection 16
 - G. Overheat Protection 16
 - H. Ozone Generator Monitor 16
- Add Start Up Chemicals..... 16

- Jet Operation 17
 - A. Three Way PowerDiverter Valve 17
 - B. Turbo Massage Jet 17
 - C. Directional and Rotational Massage Jets 18
 - D. Directional Mini Massage Jet 18
 - E. Air Control 19
 - F. Cluster 19

SPA MAINTENANCE

- Filter Maintenance 20
- Draining Your Spa 20
- Winterizing Your Spa 21
- Natural Redwood..... 21
- Cover Maintenance..... 21
- Care of Acrylic Surface and Spa Pillows . 21
- Spa Light Colors & Lenses 22
- Spa Light Bulb Replacement 22
- Diverter Valve Cleaning 22

WATER QUALITY & MAINTENANCE

- Sanitizing 23
- pH Control 23
- Important Maintenance Procedures . 24
- Balancing Spa Water 25-27
- Water Maintenance Do's and Don'ts 28
- Water Troubleshooting 29-30

DIAGNOSTICS & TROUBLESHOOTING

- Diagnostic Messages 31
- LCDDisplay 32

Congratulations!

Thank you for the purchase of your new VITA SPA. You are now the proud owner of one of the most comfortable and therapeutic spas in the world.

This Owner's Manual has been designed to familiarize you with your Vita Spa operations and general maintenance. We suggest that you take some time to carefully review it. Please keep this manual available for reference.

If you have any questions regarding your Vita Spa set-up, operations, or maintenance, please contact your Authorized Vita Spa Dealer.

Consumer satisfaction is important to us. We welcome your comments and suggestions. Please share them with us via telephone, letter, or E-mail us at vita@vitabathandspa.com.

Sincerely,

Eric Dormoy,

President

DM Industries, Ltd.

IMPORTANT SAFETY INSTRUCTIONS

WHEN INSTALLING AND USING THIS ELECTRICAL EQUIPMENT, BASIC SAFETY PRECAUTIONS SHOULD ALWAYS BE FOLLOWED, INCLUDING THE FOLLOWING:

WARNING – To reduce the risk of injury, do not permit children to use this product unless they are closely supervised at all times.

DANGER – RISK OF ACCIDENTAL DROWNING. Extreme caution must be exercised to prevent unauthorized access by children. To avoid accidents, ensure that children can not use the spa unless they are supervised at all times.

A ground terminal (pressure wire connector) is provided on the control box inside the unit to permit connection of a minimum No. 8 AWG (8.4 mm²) solid copper bonding conductor between this point and any metal equipment, metal water pipe, metal enclosures of electrical equipment, or conduit within five feet (1.5m) of the unit.

DANGER – To reduce the risk of injury to persons, DO NOT remove suction fittings. The suction fittings on this spa are sized to match the specific water flow created by the pump. Should the need arise to replace the suction fittings or the pump, be sure that the flow rates are compatible. Never operate the spa if the suction fittings are broken or missing. Never replace a suction fitting with one rated less than the flow rate marked on the original suction fitting.

Install the spa – so proper drainage is provided for the compartment containing electrical components.

DANGER – RISK OF ELECTRICAL SHOCK – Install at least 5 feet (1.5 m) from all metal surfaces. (A spa may be installed within 5 feet of a metal surface if each metal surface is permanently connected by a minimum No. 8 AWG (8.42 mm²) solid copper conductor attached to the wire connector on the terminal box that is provided for this purpose). National Electrical Code ANSI/NMFP A70-1993.

DANGER – RISK OF ELECTRICAL SHOCK – Do not permit any electrical appliances, such as a light, telephone, radio, or television within 5 feet (1.5 m) of the spa.

WARNING – TO REDUCE THE RISK OF INJURY:

- A.** The water in a spa should never exceed 40 degrees Celsius (104 degrees F). Water temperatures between 38 degrees C (100 F) and 40 degrees C (104 F) are considered safe for a healthy adult. Lower water temperatures are recommended for extended use (exceeding 10 minutes) and for young children.
- B.** Since excessive water temperatures

SAVE THESE INSTRUCTIONS

have a high potential for causing fetal damage during the early months of pregnancy, pregnant or possibly pregnant women should limit spa temperature to 38 degrees C (100 F).

- C.** Before entering a spa, the user should measure the water temperature with an accurate thermometer, since the tolerances of water temperature regulating devices vary.
- D.** The use of alcohol, drugs, or medication, before or during spa use, may lead to unconsciousness with the possibility of drowning.
- E.** Persons suffering from obesity or with

a medical history of heart disease, low or high blood pressure, circulation system problems, or diabetes, should consult a physician before using a spa.

- F.** Persons using medication should consult a physician before using a spa since some medication may induce drowsiness, while other medication may affect heart rate, blood pressure and circulation.

DO AND DON'TS

- DO** Make sure the spa is connected to a Ground Fault Circuit Interrupter (GFCI) protected circuit. This GFCI is required by the National Electrical Code (NEC). and must be installed by licensed electrician. Test the GFCI monthly.
- DO** Test the water with your hand before entering the spa to be sure it is comfortable.
- DO** Remember that wet surfaces can be slippery. Take care when entering and exiting the spa. Only enter by way of the steps in the spa. Do not step on spa edges or filter lids.
- DO** Use the thermal cover when the spa is not in use, empty or full.
- DO** Take steps to prevent the intrusion of sand and dirt into the spa.
- DO** Maintain proper water chemistry.
- DO** Clean the filter cartridge weekly.
- DON'T** Use the spa for long periods of time at temperatures over 104°F.
- DON'T** Operate the spa without water. Turn the circuit breaker off before emptying the spa and while it is empty.
- DON'T** Store chemicals in the spa's equipment compartment.
- DON'T** Open the electrical box. There are no user serviceable parts inside.
- DON'T** Operate the pump(s) on hi-speed for extended periods of time with the cover on. Extended hi-speed pump operation will cause a slow heat build-up due to water friction, which could trip the spa's hi-limit thermostat.

WARNINGS

Prolonged immersion in water that is warmer than normal body temperature can result in a dangerous condition known as HYPERTHERMIA. The causes, symptoms, and effects of hyperthermia may be described as follows: Hyperthermia occurs when the internal temperature of the body reaches a level several degrees above the normal body temperature of 98.6 degrees F. The symptoms of hyperthermia include dizziness, fainting, drowsiness, lethargy, and an increase in the internal temperature of the body. The effects of hyperthermia include (1) unawareness of impending hazard, (2) failure to perceive heat, (3) failure to recognize the need to exit the spa, (4) physical inability to exit the spa, (5) fetal damage in pregnant women, and (6) unconsciousness resulting in a danger of drowning.

WARNING – The use of alcohol, drugs, or medication can greatly increase the risk of fatal hyperthermia in spas. Persons taking medications that induce drowsiness such as tranquilizers, antihistamines or anticoagulants should not use the spa. Pregnant women and persons with a medical history of heart disease, circulatory problems, diabetes or high blood pressure should consult their physician before using the spa.

Children are especially sensitive to hot water. At no time should children have unsupervised access to the spa. The use of elevated decking may encourage children to climb onto the thermal cover – **IT IS NOT DESIGNED AS A SAFETY OR CHILD RESISTANT COVER!**

Every Vita Spa comes with a thermal cover which is provided with locking straps. **Install the locks for your child's safety.**

INSTALLATION INSTRUCTIONS

SITE SELECTION / PREPARATION:

The spa must be installed on a structurally strong, solid and reasonably level surface. The majority of the weight of the spa is placed under the footwell area of the spa. This area must be firmly supported at all times. The site should allow for drainage away from the equipment compartment in which the electrical components are housed. Take into account the following when considering prospective sites.

Vita Spas have a loading capacity in the range of 57lbs/sq ft to 83 lbs/sq ft. Refer to your actual model for exact loading requirements.

LOCAL CODES:

There may be certain restrictions and/or requirements that are particular to your locality.

DELIVERY PASSAGEWAY:

Doors, halls, stairs, etc. may pose obstructions to deliver the spa to its intended site.

MAINTENANCE:

Trees, lawn, placement surfaces, etc. can create extra work in keeping your spa area clean and safe. Please be advised that placing your spa on dirt or grass may increase the amount of debris inadvertently brought into the spa water on the feet of users or by the wind. The intrusion of this debris into the spa water may cause harm to your equipment as well as the spa surface and is not covered under warranty.

PRIVACY AND WIND SHIELDING:

A sheltered environment can result in lower operating and maintenance costs. You may also want to take into consideration your privacy during times of the year when trees may be barren, having the spa located where you have a view of a peaceful sunset, where you may be able to catch soothing breezes, or your view and the view of your neighbors may also be something that you should address prior to the final installation of your spa.

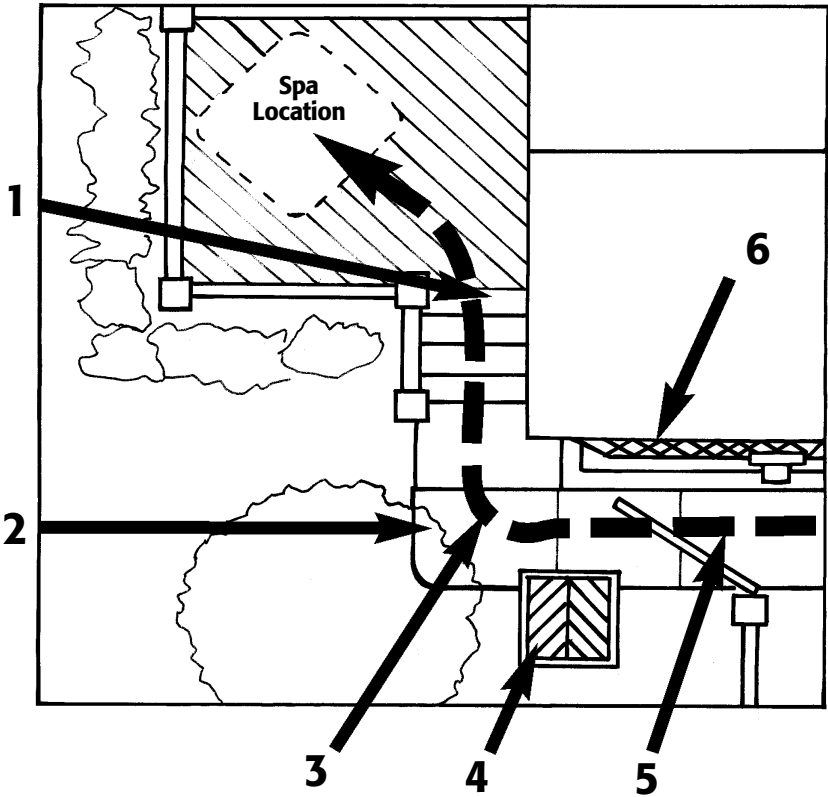

CLEARANCES

CHECK THE FOLLOWING AREAS PRIOR TO SPA DELIVERY

1. STEPS - We suggest no more than six without a landing.
2. TREE BRANCHES - Clearance for spa passage.
3. TIGHT CORNERS - Make sure there is space to maneuver.
4. STORAGE SHEDS, DOG HOUSES, WOOD PILES - Remove out of the way.
5. GATES: CLEARANCE FOR PASSAGE OF SPA - Does gate need to be removed from hinges?
6. OVERHANGS AND GUTTERS - Anything overhead, as well as drain pipe locations, must allow for spa passage.

ELECTRICAL REQUIREMENTS AND INSTALLATION

WIRE YOUR SPA PER ONE OF THE DIAGRAMS MOST SIMILAR TO YOUR HOUSE PANEL

ALL WIRES FEEDING THE SPA ARE TO BE THE SAME GAUGE. GROUND WIRES ARE TO BE INSULATED AS WELL. WHEN USING A GROUND ROD, THE GROUND WIRE TO THE ROD SHOULD BE #6 BARE COPPER.

ALL SPAS REQUIRE THE USE OF AN ISOLATED GFCI PROTECTED CIRCUIT. THE INSTALLATION OF A DISCONNECT IS REQUIRED NO MORE THAN TEN (10) VISUAL FEET FROM THE SPA AND NOT LESS THAN FIVE (5) FEET.

THIS REQUIREMENT IS TO ASSURE THAT WHEN POWER IS DISCONNECTED FROM THE SPA, POWER CAN NOT BE INADVERTENTLY TURNED BACK ON.

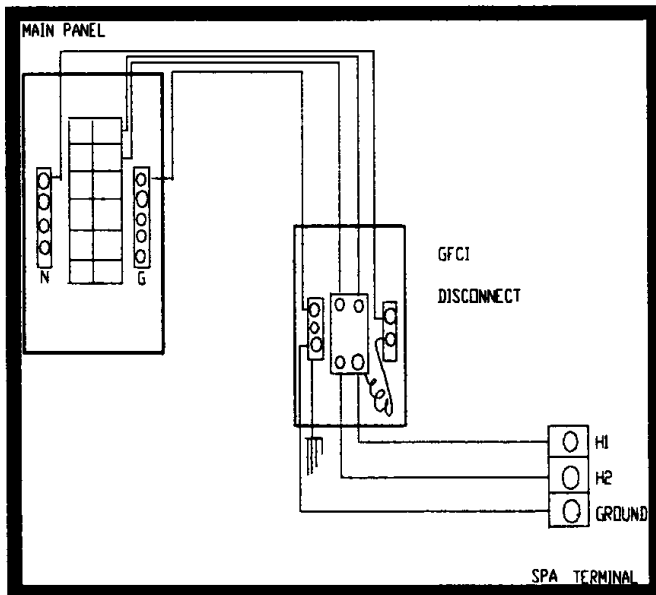

SEPARATE NEUTRAL & SOLID GROUND

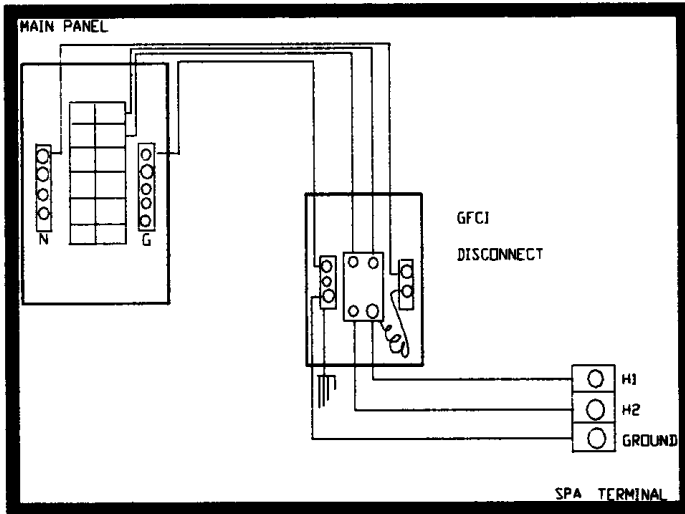

**SEPARATE NEUTRAL & WEAK
GROUND OR ROMEX WIRE USED TO
FEED GFCI WITH UNDERSIZED
GROUND WIRE**

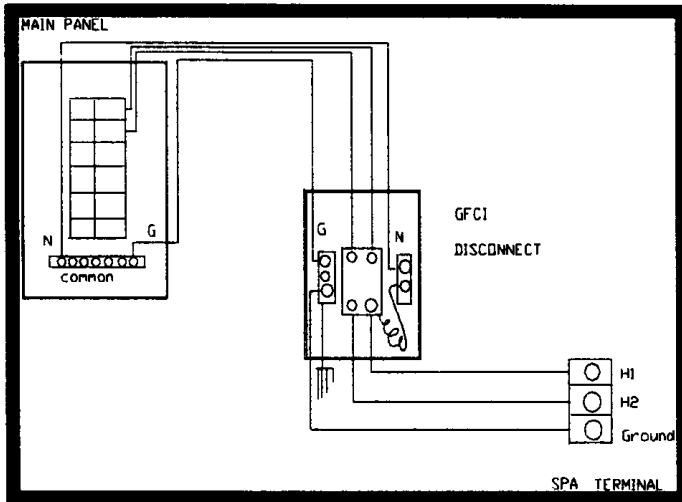

**COMMON NEUTRAL GROUND BAR
IN MAIN**

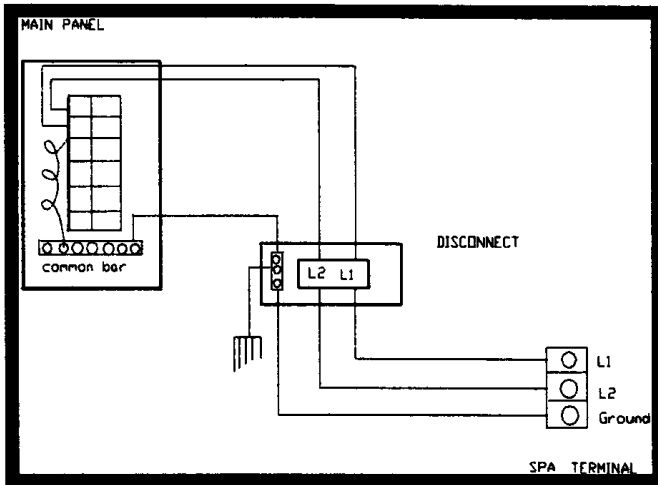

GFCI IN PANEL WITH COMMON NEUTRAL BAR AND/OR ROMEX WITH UNDERSIZED WIRE USED TO FEED DISCONNECT.

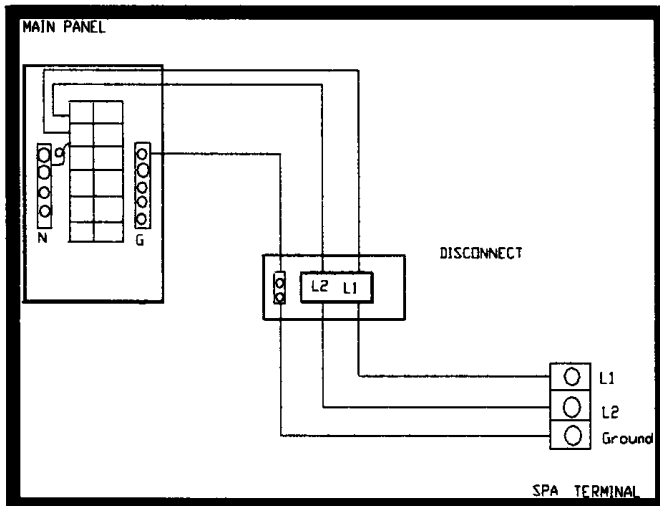

GFCI IN PANEL WITH SEPARATE NEUTRAL AND SOLID GROUND TO PANEL

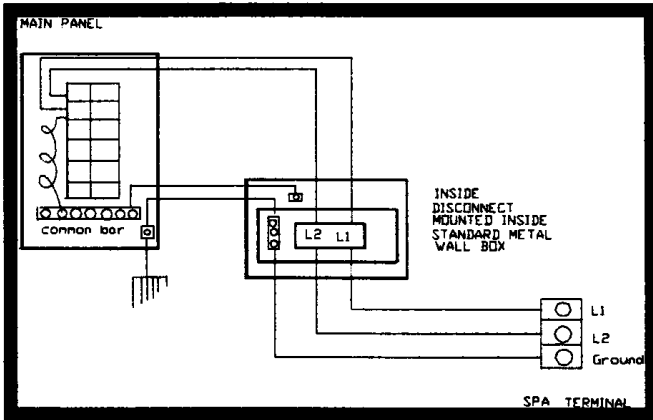

GFCI MOUNTED IN PANEL AND DISCONNECT MOUNTED INSIDE TO COMMON WALL WITH METAL STUDS OR WITH METAL MOUNTING BOX.

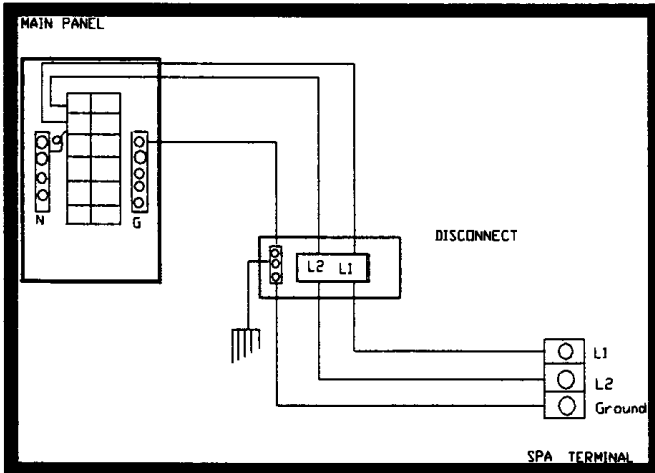

GFCI IN PANEL WITH WEAK GROUND OR ROMEX WITH UNDERSIZED GROUND WIRE USED TO FEED DISCONNECT

ALL WIRING TO THE SPA SHOULD BE IN ACCORDANCE WITH ALL LOCAL AND NATIONAL ELECTRICAL CODES. ALL WIRING SHOULD BE PERFORMED BY A LICENSED ELECTRICIAN KNOWLEDGEABLE IN THE OPERATION AND WIRING OF A GFCI PROTECTED SYSTEM.

1. The spa must be permanently connected (hardwired) to the power supply. No extension cords or plug-type connections are to be used in conjunction with the operation of the spa. Failure to supply power to the spa that is not in accordance with these instructions could create a potential health hazard and will void both the manufacturer's warranty and the independent testing agency listing.
2. **The National Electrical Code (NEC) requires that the power supply to this spa must be a dedicated, ground fault circuit (GFCI) protected circuit with no other appliances or lights sharing power on this circuit.**
3. Refer to the wiring diagram posted inside the electrical equipment door to determine the current, voltage, and wire size requirements for your spa.
4. THHN type wire is recommended. The wire size for the distance of the wire run must conform to NEC and local electrical codes.
5. To ensure proper connections use copper conductors only.
DO NOT USE ALUMINUM WIRE.
6. The spas' power terminal strip is located within the electrical control box.
7. **Feed supply conductors through power supply inlets provided on the spa and install into the control box. Modifications to the electrical equipment box are not permitted. Drilling holes in the electrical control box to provide access for wires in areas other than those provided for will void the manufacturer's warranty and the independent testing agency listing.**
8. Connect wires to terminal block (TBI) color for color. All wires must be connected or damage may result.
TIGHTEN SECURELY!

COVER INSTALLATION

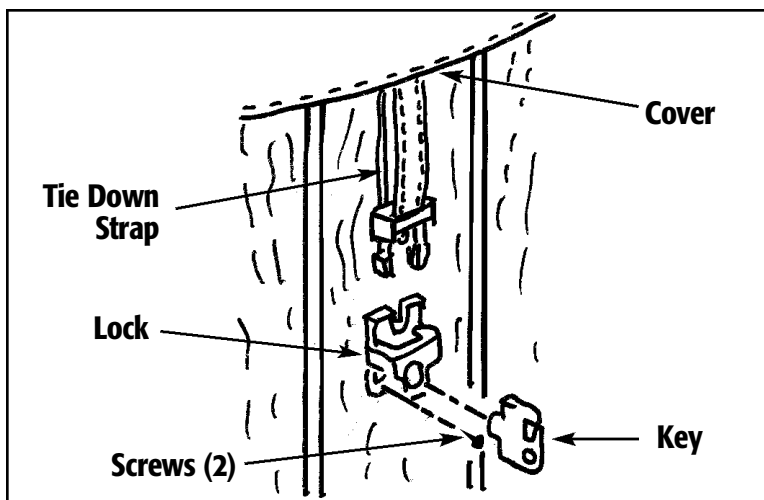

INSTALLING THE SPA COVER

1. Position the cover squarely over the spa.
2. Position the locks for the tie-downs on the sides of the spa. You should allow approximately 1/2" to 3/4" slack in the straps for ease of insertion into the locks and to allow for material shrinkage during temperature changes.
3. Using the screws provided, attach the locks and insert the cover tie-down straps. Utilizing the cover anytime the spa is not in use will reduce heat loss and thereby reduce the amount of running time required to make up that loss by the heating system.

Keep cover fastened down at all times when not in use.

DANGER - RISK OF INJURY

To reduce the risk of potential injury:

1. **Never leave a spa uncovered or unattended.**
2. **Never leave a spa cover unlocked.**
3. **Do not stand, sit, or lie on the cover.**

ALWAYS REMOVE SNOW FROM THE COVER. THE COVER HAS NOT BEEN DESIGNED TO SUSPEND THE WEIGHT OF WET SNOW.

OPERATING INSTRUCTIONS

NOTE: For best results, read each step carefully and entirely before proceeding to the next.

FILLING YOUR SPA

Wipe the interior of the spa with a damp, soft cloth to remove any residue that may be on the surface. Fill with a garden hose by inserting the nozzle of the hose in the filter inlet. (After filling is complete, remember to put the filter cartridge in place prior to starting the spa.) As the spa is filling, check in the equipment access area for any leaks. On occasion, it may be necessary to hand tighten a union fitting that may have come loose during transit. Also check that the gate valves are pulled out to the open position and that the hose bib is closed. Continue to fill to the water line.

WATER LINE _____

NOTE: If your water is extremely hard, it is preferable to fill the spa halfway with hard water and the rest with softened water. Never fill the spa entirely with softened water.

INITIAL START UP

Your L100 Series spa has been factory programmed for your convenience. Once properly connected, the filtration pump and heater will automatically come on and heat the spa to 102 F.

Initial temperature, day, time and filtration cycles can be set and changed by following the instructions shown below.

A. SETTING TEMPERATURE:

1. Press **"PROG"** to display water temperature.
2. Press **"UP"** or **"DOWN"** arrows to choose the desired temperature. Notice the heater icon flashing.
3. Wait 30 seconds or press any function buttons (**"Jet"** or **"Light"**) to exit the programming mode.

B. AUTO HEAT AND ECONOMY MODE

Your spa has been designed to operate in two heater control modes: **AUTO HEAT ("AH")** and **ECONOMY ("ECO")**. In the **AUTO HEAT** mode, the pump and heater will turn on whenever the water temperature falls 1 degree below the chosen temperature. Your spa has been preset to start upon activation in the **AUTO HEAT** mode. The spa water will be automatically heated to the temperature you choose or to the preset temperature of 102 F.

In the **ECONOMY** mode, the pump and

heater will only come on during programmed hours. (See "Setting Filtration Hours"). Note that, if at the end of filtration cycle the water is not at the chosen temperature, the pump and heater will not continue to run until that temperature is reached. This mode is used for energy conservation, the same way you would control your heat or air conditioning in your house. The clock icon will be displayed when in **ECONOMY** mode.

To switch to the **ECONOMY** mode:

1. Press and hold the **"PROG"** button for 5 seconds to enter the programming mode. **"AH"** will flash on the display.
2. Press **"UP"** or **"DOWN"** button to change between **ECONOMY (ECO)** and **AUTO HEAT (AH)**. Observe the clock icon when in **ECONOMY** mode.
3. Wait 30 seconds or press "Light" button to exit the programming mode.

C. SETTING CURRENT TIME

1. Press and hold the **"PROG"** button for 5 seconds to enter the programming mode. **"AH"** will flash on the display. If you are already in the programming mode, go to step 2 directly.
2. Press **"PROG"** one more time to show the Hour. Observe the flashing clock icon and PM indicator. No indicator means AM.
3. Press **"UP"** or **"DOWN"** to select the current hour.
4. Press **"PROG"** one more time to show the minutes.
5. Press **"UP"** or **"DOWN"** to select the current minute.
6. Wait 30 seconds or press the "Light" button to exit the programming mode.

D. SETTING FILTRATION CYCLES

Filtration cycles have been preset at the factory from 8 AM to 10 AM and from 4PM to 6 PM. They can be changed as follows:

1. Press and hold the **"PROG"** button for 5 seconds to enter the programming mode. **"AH"** will flash on the display. If you are already in the programming mode, go to the step 2 directly.
2. Press **"PROG"** three times to show the filter cycle schedule. Notice the flashing filter icon.
3. Press **"UP"** and **"DOWN"** to change the hour.
4. Press **"JET"** button to change the filter from "-" (Off) to "F" (ON) or vice versa.
5. Wait 30 seconds or press the "Light" button to exit the programming mode.

USING YOUR SPA

A. DISPLAYING TIME OR TEMPERATURE

Pressing the **"PROG"** button will switch the display between current time and current water temperature.

B. WATER JET THERAPY

Your spa is equipped with one or two therapy pumps that can be activated as follows.

Jet Button:

SINGLE PUMP SYSTEM: L115 & L130

1. Press **"JET"** to activate the Relaxation Therapy mode.
2. Press **"JET"** to activate the Power Therapy mode.
3. Press **"JET"** to turn pump off

DUAL PUMP SYSTEM: L160

1. Press **"JET"** to activate the Relaxation Therapy mode.
2. Press **"JET"** to activate pump #1 Power Therapy mode.
3. Press **"JET"** to activate pump #2 Power Therapy mode.
- 4 Press **"JET"** to de-activate pump #1.
- 5 Press **"JET"** to de-activate pump #2.

Note that for safety, all jet modes will automatically turn off after 30 minutes. Reactivate any therapy mode as indicated above.

C. TURNING ON THE LIGHT

Your spa is equipped with an underwater light. Press the light button to activate and de-activate the light. If left on, the light will automatically turn itself off after 6 hours.

SPECIAL FEATURES

A. AUTOMATIC JETS PURGE ON 2 PUMP SYSTEMS

Once each day, at 10 AM the jet pump(s) will automatically run for one minute to circulate potential stale water in the piping. This is a normal function of the spa. The display will show **"BJ2P"** while this takes place. Note that this feature only affects 2 pump systems (L160).

B. MEMORY

All settings that are entered into your spa controller will be permanently retained in its solid-state memory. In the event of a power failure, the time will be captured

and held until power returns. All settings existing at the time of the power failure will be restored when power returns.

C. SYSTEM RESET

Anytime there is reason to believe that your spa electronic system is not operating properly, perhaps as a result of lighting or other interference, like your PC at home, your spa system can be simply reset by holding down the **"DOWN"** arrow button for 5 seconds while in the time display mode. The system will be reset, maintaining all the settings you had in memory.

D. PANEL LOCK

The Selectron 100 spa panel can be locked to keep children or others from using any of the spa functions. To deactivate all buttons, make sure **"Time"** is displayed. Use **"PROG"** button to change to **"Time"** display if needed. Then hold the **"UP"** arrow button for 5 seconds. Notice the flashing lock icon. The panel is locked. To unlock the panel, hold the **"UP"** arrow button for 5 seconds again. The flashing lock icon will disappear and all spa functions will be accessible.

E. FREEZE PROTECTION

If temperature in the spa plumbing falls below 50 degrees Fahrenheit (10 degrees Celsius) the water pump(s) will turn on and run for at least one minute. The display will show **"ICE"**. After one minute, if the water is still below 50 degrees F (10 degrees Celsius), the heater will turn on and raise the water temperature 10 degrees F.

F. FLOW PROTECTION

If the flow of water through the heater is insufficient, the spa controller will automatically turn the heater off to prevent overheating. The display will show "FLO", indicating a flow restriction caused by a clogged filter, shut gate valves or by a malfunction in the pressure switch. Call for service if you cannot pinpoint the cause.

G. OVERHEAT PROTECTION

If the water temperature inside the spa reaches 112 F, the display will show "**HILI**" (High Limit) and the heater will be disabled. If the water temperature continues to rise and reaches 115 F due to friction in the pumps and plumbing system, the entire system including all pumps will be disabled. In "**HILI**" condition, **DO NOT ENTER THE WATER**. Remove the cover and allow the water temperature to cool down to 104 F. Then, reset the system by holding down the "**PROG**" button for 5 seconds while in time display mode. If the "**HILI**" message returns, call for service.

H. OZONE GENERATOR MONITOR

If your spa is equipped with a Vitazone ozone generator, the ozone bulb is monitored by the spa controller. Should the bulb burn out, or should the ozonator fail, the message "O3" will appear on the display, signaling the need for service. Note that this feature will not be available if your spa is equipped with an ozonator that is not a "VitaZone".

ADD START UP CHEMICALS

Carefully follow the directions and add the start-up chemicals recommended to you by your dealer. Contact your dealer to clarify any questions you may have. Your spa comes ready for the Vita exclusive "**Sparkle Clear**" natural mineral purification cartridges. Combined with an ozonator, "Sparkle Clear" offers an alternative to Bromine or other chlorine sanitizers. Sparkle Clear and ozone will make your spa look cleaner, smell cleaner, feel softer and eliminate skin or eye irritation. Ask your dealer about Vita Spa's "Sparkle Clear" sanitizing alternative.

JET OPERATION

Your Vita Spa is designed with a unique jet system to allow you to select a wide variety of massage patterns. The following is a description of the various types of jets and their operation you may use to tailor your spa to your specific massage needs.



(A) THREE WAY POWER DIVERTER VALVE

The Power Diverter Valve allows water to be diverted to a zone of jets or to the Turbo jet exclusively, or to both combined. Turning the valve to the left, water will be diverted to "A" jet(s) giving that zone the maximum output. Rotating the valve to the right will give "B" jet(s) the maximum output. When turned to the center, both "A" and "B" will operate simultaneously

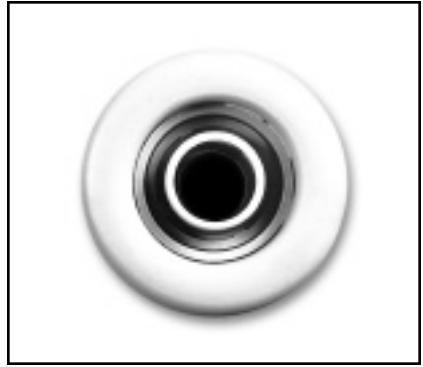

(B) TURBO MASSAGE JET

With the Power Diverter Valve turned to "A" or "B" depending on the spa model, the water will be delivered exclusively to the Turbo Massage Jet. The Turbo massage therapy is great for working out those hard-to-relieve muscle knots and to create swirling whirlpool effect in the spa. The Turbo Massage jet pressure can be adjusted by rotating the Power Diverter Valve between "A" and "B" positions.

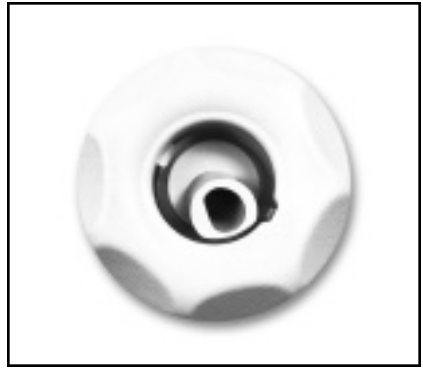

(C) DIRECTIONAL AND ROTATIONAL MASSAGE JETS

When the pump(s) is on and the Turbo massage jet is in the off position, the Directional Quad jets and Rotational Therapy jets will be operational. The nozzle of the Directional Quad jets can be adjusted to direct the flow to specific part of your body. The Rotational jets provide a “swirling” type therapy. The water pressure can be adjusted in both jets by rotating the outer rim of the jet clockwise for minimum pressure and counter clockwise for maximum pressure. Water pressure can also be varied by opening or closing the air control.



(D) DIRECTIONAL MINI MASSAGE JET

These jets are used for neck and shoulder massage. They deliver a firm pinpoint jet stream of massaging action that can be directed to specific areas of the neck or shoulders. They can be pressure controlled by rotating the jet face or by opening and closing the air control valves.



(E) AIR CONTROL

The Air Controls are used to introduce air into the water jet stream. They allow the user to increase (open) jet pressure or decrease (close) jet pressure as desired.

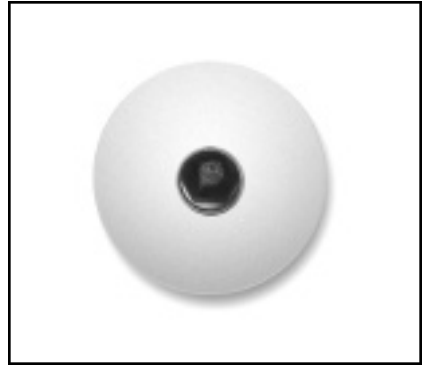

(F) CLUSTER JETS

These jets work as a team, that's why they're usually found in groups of two or more. They can deliver vigorous pinpoint action for a therapeutic effect, or you can turn into soothing massage with just a twist of your finger.

SPA MAINTENANCE

Your Vita Spa is manufactured with the highest quality and most durable materials available. A spa care and maintenance program is recommended to increase your comfort, maintain the spa's reliability, and protect your investment.

FILTER MAINTENANCE

Vita Spas are designed with the most efficient top loading filtration system in the industry. Filter maintenance is the most critical factor in keeping your spa water clean.

TO CLEAN THE FILTER:

(NOTE: Never run the spa without a filter installed)

Remove the cartridge and spray it with a garden hose. It will be necessary to rotate the cartridge while spraying so as to thoroughly remove the debris lodged between the filter pleats.

After allowing to dry, inspect the cartridge for calcium deposit (scaling) or an oil film. Rapid mineral build-up from hard water, or oil build-up from the use of oil-based water scent or body oil may coat the filter cartridge. A filter cleaner to soak the cartridge is available from your Vita Spa dealer and should be used as part of your spa maintenance. Use a rag to remove any debris at the bottom of the filter housing and inside the filter screen. Replace the cartridge in the filter housing. We recommend the use of a spare filter. This way one can be soaking and cleaning while you continue to enjoy the use of your spa.

DRAINING YOUR SPA

Detergent residues from bathing suits as well as soap film from your body may

gradually accumulate in the water. Foam inhibitors will suppress the foam but will not remove the soap from the water. Eventually, the soap build-up in the water will concentrate enough to leave an unclean feeling on the user's skin, causing sudsing and make the water impossible to clarify. Depending on the amount of soap input, the spa water should last between two and three months.

TO DRAIN YOUR SPA

Turn the power off at the GFCI breaker. Attach a garden hose to the bib located in the base directly below the spa control. Pull out the cover cap from the base and unscrew it from the bib. Route the outlet of the hose to an appropriate draining area. The spa will empty by gravity. Siphon or scoop out the balance of the water.

IMPORTANT: Spa water with a high sanitizer level may harm plants and grass. If you are draining your spa for the winter, be sure to fully drain water from the pipe by disconnecting the two unions at the gate valves found by each of the two speed pumps and the two unions found by the circulation pump. Drain the water pumps by removing the pump plug. Then reinstall the pump plugs. Remove the filter and clean as required. Inspect the spa shell and clean as required.

Refill the spa BEFORE restoring power to it.

WINTERIZING YOUR SPA

SPA MAINTENANCE

Your Vita Spa has been designed and engineered for year-round use in any climate. If the spa will not be used, drain it completely, following the instructions on "DRAINING THE SPA." If you intend to use the spa during the winter, keep the spa covered to prevent heat loss.

NATURAL REDWOOD

Although your spa came stained from the factory, exposure to wind, rain and sun will cause the wood to weather. Much like any piece of furniture, if your spa came with natural redwood, you will be required to preserve it from time to time (suggested minimum of two times per year). Your Vita Spa is treated with a specially formulated "water-based" stain and sealer. This sealer can be obtained through your local Vita Spa dealer. DO NOT USE URETHANE OR POLYESTER COATINGS that will prevent the wood from its need for natural moisturizing.

COVER MAINTENANCE

Your cover is manufactured from a durable marine grade, UV resistant material. Even so, monthly cleaning and periodic conditioning is recommended to maintain its beauty. To clean and condition the vinyl cover: Lightly spray the cover with a garden hose to rinse it and remove the debris. Using a large sponge or soft cloth and a mild soap solution (1 teaspoon dish washing liquid with 2 gallons of water), scrub lightly in circular motion. Then rinse it thoroughly with plenty of water. Condition the vinyl after

cleaning by applying a thin film of vinyl conditioner. NOTE: To remove tree saps, use lighter fluid (not charcoal lighter but the kind used in cigarette lighters). Use sparingly and rinse with mild soap solution afterwards. Wipe dry.

CARE OF ACRYLIC SURFACE

To maintain the surface of your spa, simply clean with a soft damp cloth (a mild detergent is okay) or with any glass cleaner. DO NOT clean the surface with any type of abrasive as it will dull the surface and natural luster of the acrylic. DO NOT use any type of oil based solvent. Such products can be very harmful to the surface of the spa and will void the surface warranty of the spa.

CARE OF SPA PILLOWS

The spa pillows will provide years of comfort if treated with care. Each pillow has been positioned above the water level to minimize the bleaching effects of chlorinated water and other spa water chemicals. It is recommended that pillows be removed and cleaned each time the spa itself is cleaned. A mild soap and warm water works best in removing body oils. ALWAYS rinse the pillows off thoroughly after applying any type of soap to assure that no residue remains. If you are winterizing your spa or do not plan on using it for a while, it is best to remove the pillows until the next use. Pillows should always be removed whenever the spa is being superchlorinated.

SPA LIGHT COLORED LENS REMOVAL

In your owners packet you will find colored lenses for your spa light. They can easily be installed or removed by placing them over the spa light and gently pushing on the outer edges to install and pulling along the edges to remove.

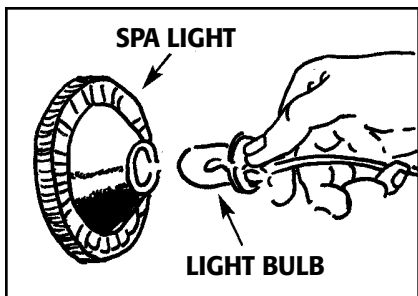

LIGHT BULB REPLACEMENT

1. Turn off the power to the spa.
2. Remove the front panel of the spa.
3. Locate the spa light.
4. Turn the bulb counter - clockwise 1/4 turn to remove from its socket
5. The replacement bulb is locked into place by turning it clockwise 1/4 turn
6. Close up the cabinet and turn the power back on.
7. Check the Top Side display and adjust the time.

DIVERTER VALVE

Over a period of time sand or grit may intrude into your spa. The diverter valves may become difficult to turn. It is important that the debris be removed as soon as possible to avoid damage to the valve.

1. Turn off the power to the spa.
2. Remove the diverter handle by pulling upward and gently rocking it.
3. Grasp the collar and turn it counter-clockwise.
4. Lift the valve body up.
5. Wipe the valve body and interior walls of the valve with a soft cloth.
6. Inspect the valve and valve walls for any grooves caused by the debris.
7. Using a fine grit sandpaper, smooth down any deep furrows.
8. Wipe the valve and wall down with a damp cloth and remove any debris left behind.
9. Lubricate the valve body with a waterproof lubricant.
10. Reassemble the valve and restore the power to the spa.
11. Check the Top Side display and adjust for time.

WATER QUALITY AND MAINTENANCE

GENERAL GUIDELINES FOR WATER QUALITY MAINTENANCE

Maintaining water quality within specific limits will enhance your enjoyment and prolong the life of the spa. Safe, comfortable and clean spa water is a fairly simple task to achieve, but it does require attention because of the numerous factors that can alter it. There is no one formula to be followed because of the variables, i.e. quality of the water used to fill the spa, water temperature, user load, etc. For specific guidelines for water quality maintenance, consult your Vita Spa dealer who can assist you to develop a program based on your specific needs. Disregard for water maintenance will result in poor soaking conditions, damage your spa investment, and possibly void your warranty.

SPA WATER MAINTENANCE CON-SISTS OF THREE SEPARATE, EASILY DEVELOPED PROGRAMS:

Sanitizing and maintaining a safe level of sanitizer in the spa water. Balancing the pH and maintaining the recommended mineral content level. Achieving and maintaining water clarity.

SANITIZING

To destroy bacteria and organic compounds in the spa water, a sanitizer must be used regularly. The use of ozone as an oxidizer has proven to be an effective method to help maintain water cleanliness, but a residual chemical sanitizer such as bromine, the most common sanitizer used in spas, must

be used in conjunction with ozone. Do not drop bromine tablets directly in the spa. The use of a floater is required to dispense safely and properly the right amount of bromine in the spa water. A bromine residual of 2 to 3 PPM is generally considered desirable. A two-part bromine system or granular chlorine (Dichlor) are also acceptable sanitizers.

pH CONTROL

pH is a measure of acidity and alkalinity of the spa water. The recommended pH for spa water is 7.4 to 7.6 PPM. Below 7.0 (considered neutral), the spa water is acidic and can cause damage to the heating system. Above 7.8 the water is too alkaline and can result in cloudy water and scale formation on the spa shell, heater and cover.

IMPORTANT: NEVER USE CHLORINE TABLETS (TRICHLOR) IN YOUR SPA.

This chemical can have an extremely corrosive effect on certain materials in the spa. Also, the use of liquids, chlorine or acid, are not recommended. Damage caused by use of any chemical, is not covered under the spa warranty.

IMPORTANT WATER MAINTENANCE PROCEDURES

DAILY

3 days a week

Check water level. Keep water above bottom of skimmer door and a minimum of 1" above highest jet.

Check and adjust chlorine level to 1.0 to 3.0 ppm if chlorine is used as sanitizer. If Sparkle Clear is used, check weekly.

WEEKLY

Once a week

Test the spa water using 3-way water test strips

Adjust pH and total alkalinity. pH: 7.4 to 7.6 (ideal 7.6).

Total Alkalinity: 80 to 120 ppm

Maintain 1.0 to 3.0 ppm bromine or free chlorine.

Add 1 ounce of additive, such as "Spa Defender," to prevent calcium build-up.

Calcium hardness: 120 to 250 ppm.

Spray filter element to remove loose particles.

MONTHLY

Four to six weeks

Inspect and clean the spa filter cartridge. It is important to maintain your spa filter cartridge and keep it clean and free of particles which can restrict water flow. If the filter is not cleaned on a regular basis, the filter may clog and restrict water flow, which causes improper filtration and poor jet performance. See "Filter Cleaning" instructions.

Two to three months

Drain your spa. Follow the procedures outlined in "Draining Your Spa" page 20 and clean it following the procedures on page 21. When refilling your spa, be sure to follow the procedures outlined in "Balancing Your Spa Water" on the next page.

WATER MAINTENANCE

BALANCING THE SPA WATER

Water treatment is an important factor in the enjoyment of your Vita Spa. Proper water sanitation is essential to your health as well as permitting years of trouble-free use of your spa. The most common water chemistry problems that can damage your spa are:

1. Improper pH maintenance. pH balance is critical to proper water maintenance. Too low of a pH level will result in corrosion of the spa's components.
2. Not pre-dissolving chemicals before adding to the water.
3. Use of improper chemicals.
4. Over chlorination. Sodium dichlor is the recommended type of sanitizer. Sodium dichlor dissolves easily and has a neutral pH, which minimizes the effect that the addition of a sanitizer has on a pH balance. Trichlor compounds are not recommended because they have a very low pH, and are very potent and difficult to dissolve.

BALANCING YOUR SPA WATER

The instructions below will assist you with balancing the spa water for the first time. You will need the following items to balance your spa water.

1. "3-WAY TEST STRIPS"
2. "PH-UP" and "PH-DOWN" for pH control.
3. "MINERAL SURFACE PROTECTOR" for Calcium and Scale control.
4. "METAL INHIBITOR" for breakdown of mineral deposits.
5. "POTASSIUM PEROXY MONOSULFATE" for shock treatment.
6. "BROMINE" or "CHLORINE" for sanitizing the spa water.

BALANCING THE SPA WATER

Please read "WATER MAINTENANCE" then follow these easy steps:

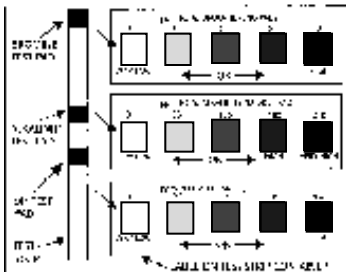
1. Fill your spa until the water level is 1 inch above the highest jet. It is NOT advisable to use softened water in your spa, as may become corrosive.
2. Add a 1/2 pint of Spa Metal Inhibitor to prevent iron or copper deposits from staining the finish of your spa. If your water is known to contain high concentrations of these metals it may be necessary to add an additional quantity of Spa Metal Inhibitor.
3. Use a 3-Way Spa Water Test Strip or test kit to measure the pH and Alkalinity of your water. The following instructions utilize test strips for testing. Immerse the test strip in the spa water, following the instructions on the test strip container label. Compare the strip to the label to determine the condition of the spa water.

The diagram shows a vertical test strip with three distinct sections. The top section is labeled 'ALKALINITY' and has a color scale from light yellow to dark brown. The middle section is labeled 'pH' and has a color scale from light yellow to dark brown. The bottom section is labeled 'CHLORINE' and has a color scale from light yellow to dark brown. Arrows indicate the direction of color change for each section.
4. If the Alkalinity is not within the acceptable range (80 to 120 ppm) it should be adjusted first. If it is low, raise the alkalinity by adding PH-UP 1 oz. at a time, retesting until the alkalinity reaches 120 ppm. If the alkalinity is high, it should be lowered by using PH-DOWN 1oz. at a time.
5. After the alkalinity is properly adjusted, the pH is next. If the pH is above 7.8, use PH-DOWN (1 oz. at a time) to lower it to the acceptable range. It is extremely important to NEVER allow the pH of your spa water to be under 7.0, as this can severely damage your equipment and will void the warranty.
6. Add Sanitizer, either chlorine or bromine. For Chlorine: Follow the directions on the bottle. Chlorine dissolves rapidly; you should get a reading on the test strip within minutes of application. For Bromine: Follow the directions on your floating brominator. It is necessary to add sodium bromine only when the spa is being filled. Bromine tablets erode slowly, and it may take several hours before you will get a reading on the test strip. It may be necessary to adjust the floating brominator.
7. To properly maintain the chemical balance of your spa, follow the 3 day a week program outlined on pages 27 and 29.

BALANCING THE SPA WATER

3 DAY A WEEK SPA CARE PROGRAM

MONDAY

1. TEST THE WATER USING "3-WAY SPA WATER TEST STRIPS".
2. Adjust pH and total alkalinity - Refer to pH and total alkalinity on label of "PH-UP" and "PH-DOWN".
3. Maintain 1.0 to 3.0 ppm Bromine or free Chlorine.
4. Add 1 ounce of "METAL SURFACE PROTECTOR" to prevent calcium build up.
5. Shock treat with 2 ounces of "POTASSIUM PEROXY MONOSULFATE", a nonchlorine shock, every week as needed.

WEDNESDAY

1. Nothing required if Bromine is used as sanitizer. Check and adjust Chlorine level if Chlorine is used.

FRIDAY

1. Nothing required if Bromine is used as sanitizer. Check and adjust Chlorine level if Chlorine is used.

Note: The above table is an example only. Actual spa usage will determine the amount of chemicals required to maintain proper chemical balance.

ALKALINITY

VERY LOW	0	ADD SODIUM BICARBONATE TO INCREASE
ACCEPTABLE ZONE	80	IDEAL
	120	
HIGH	180	ADD SODIUM BISULFATE TO DECREASE
VERY HIGH	240	

pH LEVEL

TOO ALKALINE	8.4	ADD pH DECREASER TO LOWER pH
SCALING ZONE	8.2	
	7.8	
COMFORT ZONE	7.6	IDEAL
	7.4	
	7.2	
TOO ACIDIC	7.0	
CORROSIVE ZONE	6.8	ADD pH INCREASER TO RAISE pH

SANITIZER LEVEL

ppm	DO NOT USE SPA UNTIL TEST KIT READING IS BELOW 5.0 ppm
5.0-	RECOMMENDED LEVEL SAFE
4.0-	
3.0-	
2.0-	DO NOT USE SPA ADD SANITIZER TO REACH RECOMMENDED LEVEL
1.0-	
0-	

WATER MAINTENANCE DO'S AND DON'TS

DO Add all chemicals slowly with the hydro jets operating in high speed.

DO Use care when handling chemicals.

DO Store granulated chlorine in a cool, dry place to maintain the chlorine's freshness. Granulated chlorine will degrade if stored improperly or for a long period of time. Do not store in sunlight.

DO Maintain total alkalinity level within the recommended range of 80 to 120 ppm. The calcium hardness level should be maintained in the 120 to 250 ppm range.

DO Maintain the pH level within the recommended range of 7.4 to 7.6.

DO Maintain proper chemical balance to reduce the risk of catching or spreading infection.

DO Use granulated chlorine/bromine produced specifically for portable spas.

DO NOT Use swimming pool chemicals in your spa.

DO NOT Use household bleach (liquid sodium hypochlorine).

DO NOT Use swimming pool (muriatic) acid to lower pH. Many swimming pool water care products can cause damage to spa and equipment.

DO NOT Allow anyone to be in the spa while chemicals are being added or dissolving.

DO NOT Use incorrect products such as Trichlor, which has a very low pH (2.6), dissolves very slowly, is highly concentrated, and was designed for concrete or plaster swimming pools. It will cause damage to your spa!

CHEMICAL SAFETY INSTRUCTIONS

When using chemicals, read labels carefully and follow directions precisely. Though chemicals protect you and your spa when used correctly, they may be hazardous in a concentrated form. Observe these guidelines:

DO Accurately measure and use the exact quantities specified, never more.

DO Handle all containers with care. Store in a cool, dry, well ventilated place.

DO Keep chemical containers closed at all times when not in use. Replace caps on proper containers.

DO Allow only a responsible person to handle spa chemicals. Keep them out of the reach of children.

DO Follow the emergency advice on the product label in case of accidental contact, or if the chemical is swallowed. Call a doctor or local Poison Control Center. If a doctor is needed, take the product container along so that the substance can be identified.

DO NOT Inhale fumes or let chemicals come in contact with your eyes, nose or mouth. Wash your hands after use.

DO NOT Let chemicals get on surrounding surfaces or landscaping. Don't use a vacuum cleaner to clean up chemical spills.

DO NOT Smoke around chemicals. Fumes may be highly flammable.

SPA WATER TROUBLESHOOTING

SYMPTOM	PROBABLE CAUSE	SOLUTIONS
Cloudy Water	Inadequate filtration/dirty filter	Clean filter with a filter cleaner or degreaser.
	Excessive oils/organic matter	Shock the spa with "POTASSIUM PEROXY MONOSULFATE".
	Improper sanitation	Increase sanitizer to recommended level.
	High pH and/or high alkalinity	Adjust pH; add "PH-DOWN".
	Suspended particles/organic matter Overused or old water	Use clarifier Drain the spa, clean and refill.
Water Odor	Excessive Organics Too many chloramines bromamines - insufficient free available chlorine	Shock the spa with "POTASSIUM PEROXY MONOSULFATE".
	Improper sanitation	Increase sanitizer level to recommended level.
	Low pH	Raise pH with "PH-UP".
Chlorine Odor	Too many chloramines-insufficient free available chlorine	Shock the spa with "POTASSIUM PEROXY MONOSULFATE".
	Low pH	Adjust pH; raise pH with "PH-UP"
Musty Odor	Bacterial or algae growth	Shock the spa. If problem is visible, draining and cleaning may be required.
Foaming	Buildup of body oils, lotion and chemicals resulting in soap or detergent	Add defoamer, or drain and refill.
	Overused or old water	Drain and refill.
	Excessive organics	Shock with "POTASSIUM PEROXY MONOSULFATE".

SPA WATER TROUBLESHOOTING

SYMPTOM	PROBABLE CAUSE	SOLUTIONS
Organic Buildup/ Scum Ring Around The Tub	Body oils and dirt Inadequate filtration	Wipe off scum with a clean rag or use mild detergent. If needed, drain, refill spa, and adjust water. Clean filter with a filter cleaner or degreaser.
Algae	High pH Low free chlorine/bromine	Shock with "POTASSIUM PEROXY MONOSULFATE", adjust pH. Shock with "POTASSIUM PEROXY MONOSULFATE", maintain sanitizer at recommended level.
Eye Irritation	Low pH Insufficient free available chlorine/bromine	Raise pH with "PH-UP". Shock with "POTASSIUM PEROXY MONOSULFATE."
Skin Irritation/Rash	Unsanitary/polluted water. Chlorine/bromine level too high (above 5ppm FAC).	Maintain recommended sanitizer residual at all times; super-chlorinate. Allow chlorine/bromine level to drop below 5 ppm before using spa.
Stains	pH or total alkalinity too low.	Adjust pH and total alkalinity; use sequestering agent; drain and clean with appropriate product.
Scale	High iron or copper in water source. Too much calcium dissolved in water pH	Use sequestering agent for metals; adjust water Adjust total alkalinity and pH levels by adding the appropriate sodium bisulfate product; with concentrated scale deposits, drain the spa, clean the liner (as outlined in Liner Clean Up), refill the spa and balance the water.

DIAGNOSTIC & TROUBLESHOOTING

<u>SYMPTOM</u>	<u>MEANING</u>	<u>ACTION</u>
Spa Inoperative	Power failure outside of spa.	Check power source Breaker and GFCI; Reset breaker/GFCI. Call Electrician if it will not start.
Spa Side Inoperative	Spa Side could be locked.	If lock icon is visible, unlock by depressing the "UP" button for 5 seconds
<u>MESSAGE</u>		
BJ2P	Purging of plumbing.	Normal system operation for one minute each day at 10 AM and at 6 PM.
FLO	Lack of water flow through Heater.	Remove filter and check for debris in filter and filter adapter. If "FLO" remains check for closed gate valves or see priming the pump.
HILI	Overheating detected. 1 Heater off at 110° F Pumps off at 112° F. IF THIS HAPPENS A SECOND TIME IN A ROW, <u>DO NOT USE SPA</u> . CALL FOR SERVICE.	SEE PAGE 16. Let water temperature cool down to 104 F and reboot holding "DOWN" button for 5 seconds or until display returns to 12:00 noon. If "HILI" message returns, turn power off to spa for 15 minutes and then power up and reboot to factory settings
ICE	Water in plumbing below 50 F Call for service if spa fails to come on.	No action required. Pump will come on to circulate water and then heater. Heater will stay on until water reaches 60 F or set temperature.
BLO	Blower inoperative	Turn power off to spa and check fuse. Replace with 10 AMP MDL Fuse.
LS=O or LS=S	Water temperature sensor	Reboot the factory settings
SS=O or SS=S	High Limit sensor	Reboot the factory settings
PB	Break in communication	Reboot the factory settings

LCD DISPLAY GLOSSARY

ICON

MEANING



Still: Heater is on
Flashing: Temperature Adjustment Mode



Still: Heater adjustment is locked
Flashing: Panel lock. All buttons are deactivated



Still: Filter is On
Flashing: Filter adjustment Mode

VITA
Spa[®]

Is a Registered Trademark of

Vita International

Division of



MIAMI FLORIDA

DM Industries, Ltd., 2320 Northwest 147th Street, Miami, Florida 33054

Phone: (305) 685-2063 or (305) 908-8187 • Toll Free: (877) 240-9457

FAX: (305) 685-9794

SPA100-01-0605PDF

© 2002 DM INDUSTRIES • ALL RIGHTS RESERVED